

LASOS® **LDM-XT laser series**

Next generation laser diode modules
Fiber coupled with shutter
High coupling efficiency (60%)
60 mW at 415 nm



VLD-XT 415XX FS

- Outstanding long term stability
- Excellent beam quality
- Reliable and robust
- Maintenance free
- Compact design
- Suitable for OEM applications
- Software control via integrated USB
- Customization on request



Next generation laser diode module

LASOS® LDM-XT laser series

The LASOS LDM-XT laser series is the latest generation of laser diode modules designed to fulfil specific customer's needs for a particular application. Its modular concept allows adapting different requirements regarding optical and electrical properties. Whether it is delivered as an OEM component for instrumentation or for stand alone applications in science or research the customer has the choice between several options which ensure always the best price-performance ratio. With its compact and robust housing, easy setup and intelligent control the LASOSR LDM-XT laser series is the ideal choice when reliability and accuracy matter.

The laser diode modules are available in a free beam version or with a permanently aligned coupling into a single mode polarization maintaining fiber. The fiber patchcord can be designed by the customer choosing from various options regarding jacket and connectors. Additionally, the customer can choose from a range of optomechanical components like precision fiber plugs and sockets for adjustment free docking to an instrument or beam combining to transfer several beams into one collinear beam ore one fiber. Based on these features the new LASOS LDM-XT series is the best choice for

- Microscopy
- Flow Cytometry
- Bioanalytical Research
- Industrial Measurement
- Testing
- Science and Education

Wavelength	415 nm ± 5 nm
Spot roundness	0.5...1
Spectral Linewidth	< 3 nm
Output power	60 mW
Output power stability within 8 h	≤ ±2.0 %
Noise 30 Hz ... 10 MHz	≤ 0.5 % rms
Warm up period	< 10 min
Beam quality M ²	≤ 1.2
Pointing stability	< 6 μrad K ⁻¹
Polarization ratio	≥ 80:1
Operating voltage	12 V ± 0.1 V
Accessory	SwitchBox SSL 1000, 12 V power supply
Output type	PM fiber, 2 m, FC/APC 8° half surface polish, PVC fiber jacket

Options on request

C Circular beam

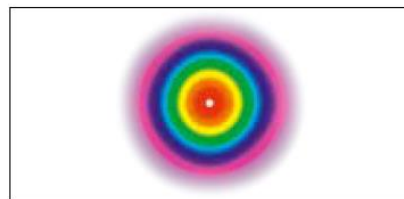

H SHINE (Speckle Homogenizer and Image Noise Eraser)

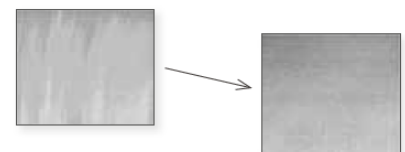

N² Narrow bandwidth (Reduced spectral width)



L Longitudinal singlemode (High coherence length)



²⁾ on request, ask for lead time

LASOS

For worldwide photonics
 LASOS Lasertechnik GmbH
 Franz-Loewen-Str. 2
 07745 Jena
 Germany
 Phone: +49 (0) 3641 2944 – 0
 Fax: +49 (0) 3641 2944 – 300
 sales@lasos.com

www.lasos.com

Dimensions:

Fiber coupled with shutter
(FS version)

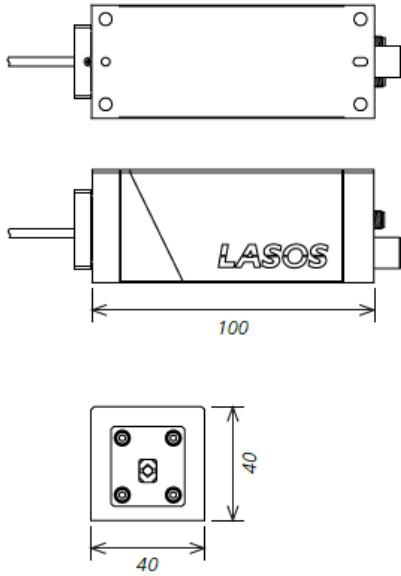

Accessory:

Accessory: Stand alone kit for LASOS LDM-XT laser series:

SwitchBox SSL 1000,
CDRH compliant

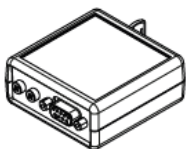

Power supply 12 V,
power cord and
interface cable included

